

# Spirit Z-Wave Plus

Installation & Operation Guide



**ET** | **EUROTRONIC**  
Technology GmbH



  
Made in Germany

[www.eurotronic.org](http://www.eurotronic.org)

# Content

---

1	Included in delivery	3	5.3	Altering the operating states	14
2	Adapters	4	5.4	Window open detection	15
			5.5	Display NodeID	15
3	Product Description	4	6	Z-Wave	16
	Technical specifications	4	6.1	Assoziation	17
	Contact information	5	6.2	Basic	17
	Warranty	5	6.3	Configuration	18
			6.4	Multilevel Sensor	18
4	Buttons and Displays	6	6.5	Multilevel Switch	19
4.1	Buttons	6	6.6	Notification	19
4.2	Boost-Buttons LEDs	7	6.7	Protection	19
4.3	LCD	7	6.8	Thermostat Mode	19
	Network behavior	8	6.9	Thermostat Setpoint	20
4.4	Inclusion	9			
4.5	Mounting the Spirit Z-Wave Plus	10	7	Troubleshooting	20
4.6	Plus Mechanical Installation	11			
4.7	Exclusion	12			
4.8	Unmounting the Spirit Z-Wave	13			
4.9	Plus Factory Rese	13			
5	Operating the device	14			
5.1	Setpoint adjustment	14			
5.2	Child protection	14			

# 1. Included in delivery

1. **Spirit Z-Wave Plus** energy-saving thermostat

2. **Screw**

3. **Adapters for Danfoss valves**

4. **2x AA batteries**

\* When using the RAV adapter, you need the RAV Pin for the extension of the valve stem.

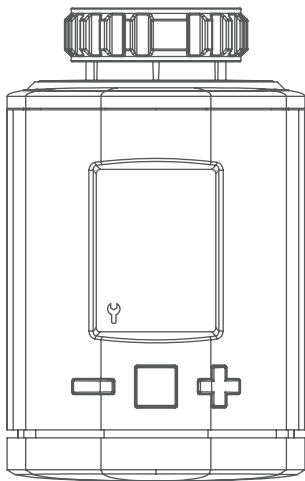

**Spirit Z-Wave Plus**  
energy-saving thermostat

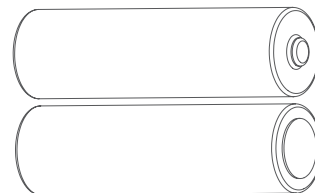
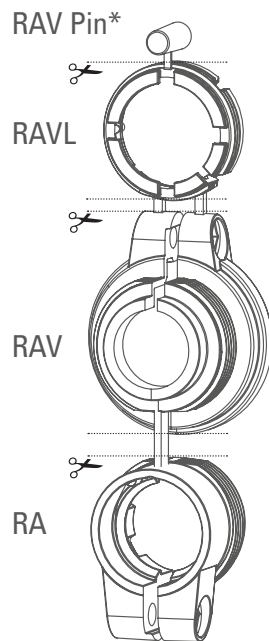

2x AA batteries

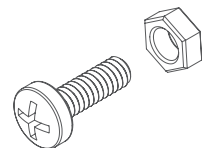

Screw for adapter

## 2. Adapters

---

**WARNING - Remove the connecting pieces of the plastic adapter completely before you use one of the supplied adapters!**

Additional adapters are available for different valve manufacturers. Please consult the EUROtronic Website for all information about the different adapters at: [www.eurotronic.org/Service/FAQ](http://www.eurotronic.org/Service/FAQ)

**For the following valves no adapter is required:**

Heimeier, Junkers Landy + Gyr, MNG, Honeywell, Braukmann, as these have a thread of M30 x 1.5mm. The adapters for Danfoss RAV (pin must be plugged on the valve tappet) Danfoss RA and Danfoss RAVL are included.

**For the following valves an adapter is required:**

Herz M28 x 1,5 mm, Comap M28 x 1,5 mm, Vaillant 30,5 mm, Oventrop M30 x 1,0 mm, Meges M38 x 1,5 mm, Ondal M38 x 1,5 mm, Giacomini 22,6 mm, Rossweiner M33 x 2,0 mm, Markaryd M28 x 1,0 mm,, Ista M32 x 1,0 mm, Vama M28 x 1,0 mm, Pettinaroli M28 x 1,5 mm, T+A M28 x 1,5 mm, Gampper 1/2/6.

If you are not sure which valve you are using, please visit: [www.eurotronic.org/Produkte/Adapter](http://www.eurotronic.org/Produkte/Adapter) for further Information. Here you will find a list of various valves and adapters.

## 3. Product Description

---

Spirit Z-Wave Plus is a Z-Wave radio standard compatible energy-saving radiator thermostat.

**FLiRS (Frequently Listening Receiver Slave):**

Spirit Z-Wave uses FLiRS to provide short latency and short responding times.

## Contact information

---

If you wish to receive further technical Support or information about other EUROtronic products, please contact us via E-Mail or telephone.

**Customer Service:**

Eurotronic Technology GmbH  
Südweg 1  
36396 Steinau - Ulmbach  
Germany

Telefon: +49 (0) 66 67 91847-0  
E-Mail: [info@eurotronic.org](mailto:info@eurotronic.org)  
Internet: [www.eurotronic.org](http://www.eurotronic.org)

# Warning

---

## **Do not use rechargeable batteries!**

Never recharge batteries, do not short circuit them, do not take them apart - Risk of explosion! Remove dead batteries from the device immediately. Do not use old and new batteries together. Clean battery and device contacts before inserting if necessary.

Keep batteries away from children. Avoid contact with skin, eyes and mucous membranes. In case of contact with battery acid, rinse the affected areas immediately with plenty of water, and seek medical attention immediately. Do not expose batteries to direct sunlight.

## **Safety Instructions:**

Spirit Z-Wave Plus is designed for use in buildings.

Operate Spirit Z-Wave Plus only as described in the user manual.

Spirit Z-Wave Plus should only be put to use in a dry and dust-free place, away from direct sunlight.

Do not keep using the device when there is obvious damage.

Spirit Z-Wave Plus may not be rebuilt, modified or opened.

# Warranty

---

The 24-months warranty period begins at the day of purchase. Please keep the receipt as evidence of purchase. During the warranty period, defective radiator thermostats may be sent to your dealer or the address below. Please ensure sufficient postage is paid. A new or repaired device will then be sent to you free of charge.

Please note that EUROtronic only grants warranty on the function of the device. EUROtronic will not grant warranty for the interaction between the thermostat and the bottom part of the valve. The technical data is only valid for the use of the following valves: Heimeier, Junkers Landys + Gyr, MNG, Honeywell, Braukmann (measure of thread M30 x 1,5), Oventrop (M30 x 1,5) Danfoss RA, RAV and RAVL. Please refer to the combinations of the devices on our website (<https://www.eurotronic.org/produkte/adapter-information.html>) EUROtronic does not issue a guarantee when using the thermostat with valves which are not mentioned above.

## **Declaration of Conformity:**

 Eurotronic Technology GmbH hereby declares that this device is compliant with the essential requirements and other relevant provisions. The declaration of conformity is provided at [www.eurotronic.org](http://www.eurotronic.org).

## **Advice on environmental protection:**

 From the date of implementation of European guidelines 2002/96/EC and 2006/66/EC, into national law, the following applies: Electric and electronic devices and batteries may not be disposed of in household waste. The consumer is obliged to return electric and electronic devices and batteries to the public collection points established for them or to the point of sale. The particulars of this are regulated by the applicable state laws. The symbol on the product, operation instructions or packaging points to these provisions. You make an important contribution to the protection of the environment by reusing or recycling old equipment/batteries or making use of them in other ways.

# Technical specifications

Device short description	Spirit Z-Wave Plus	Method of operation	Type 1
EAN	4260012712049	Dimensions	(W x H x D): 56 x 68 x 89 mm
Article Number	700201	Weight	176g (incl. batteries)
Supply Voltage	2 x 1,5V LR6/Mignon/AA	Degree of protection	IP20
Radio Frequency	868,42 MHz	Degree of pollution	2
Connection	M30 x 1,5mm		

## 4. Buttons and Display

### 4.1 Buttons

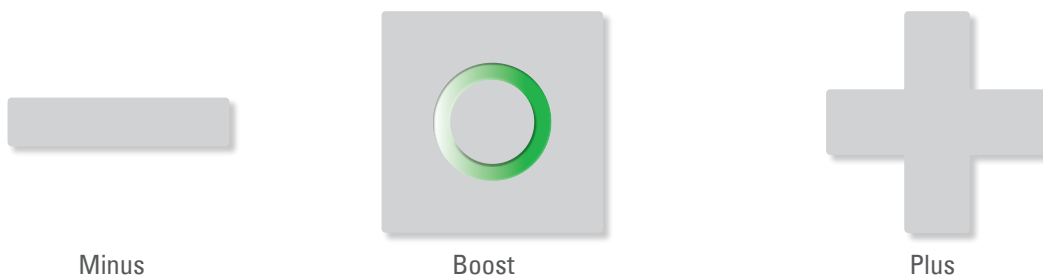

Button	Interaction	Result/Behavior
	Press once	Decrease room temperature by 0.5°C.
	Press and hold	Decrease Room temperature by 0.5°C and lower the Room temperature by 0.5°C every 0.5 seconds or until the lowest temperature is set.
	Press once	Increase room temperature by 0.5°C.
	Press and hold	Increase Room temperature by 0.5°C and raise the Room temperature by 0.5°C every 0.5 seconds or until the highest temperature is set.
	Push once	<ul style="list-style-type: none"> <li>• Confirm action which is displayed in the LCD.</li> <li>• Switch into Boost-Mode(Quick Heat).</li> <li>• Quit Boost-mode(Quick Heat) if currently active.</li> </ul>
	Hold for 3 seconds	The LCD shows the Z-Wave Node ID.
	Hold for 5 seconds	The Spirit Z-Wave Plus will react to Exclusion Commands.
	Hold while unpowered and insert batteries	Allows factory reset of the Spirit Z-Wave Plus.
	Hold both simultaneously for 3 seconds	Sets or clears the child protection.





## 4.2 Boost-Taste LEDs



Boost – green



Boost – red

Color	State	Meaning
	Lights constantly for 5 seconds	A task has failed.
	Permanently on	An error occurred. Consult manual for error code description.
	Blinking	User conformation is required to start a task.
	Lights constantly for 5 seconds	A task was completed successfully.

## 4.3 LCD



### Wrench:

Lights up if mechanical tasks are ongoing.



### Antenna:

Displays the Spirit Z-Wave Plus network state.

Segment visible: rf-link established

Segment turned off: rf-link lost



**ID:** Lights up if the Display shows the Z-Wave NodeID.



**Battery:** Lights up if less than 15% battery is remaining



**Lock:** Lights up if child protection is set.

**°C Celsius:** Displayed if the LCD shows a setpoint temperature

**% Percent:** Displayed instead of °C Icon if the Spirit Z-Wave Plus is set to direct. control mode.

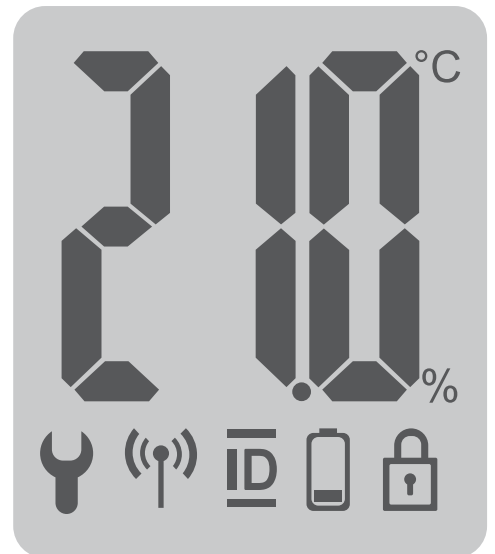

# Network behavior

---

On factory default the device does not belong to any Z-Wave network Spirit Z-Wave Plus needs to be added to an existing wireless network to communicate with the devices of this network. This process is called Inclusion.

Spirit Z-Wave Plus can also be removed from a network. This process is called Exclusion. Both processes are initiated by the primary controller of the Z-Wave network. This controller is turned into exclusion respective inclusion mode. Please consult the manual of your Z-Wave Controller how to activate Inclusion or Exclusion mode.

If Spirit Z-Wave Plus has been added to a network, it has to be removed prior to be added to another wireless network.

## Interoperability

This device and every other certified Z-Wave device can be used together with any other certified Z-Wave device regardless of brand and origin as long as both are suited for the same frequency range.

## Security

Spirit Z-Wave Plus supports secure communication. Spirit Z-Wave Plus will communicate with other devices secure as long as this device provides the same or a higher level of security. Otherwise Spirit Z-Wave Plus will automatically turn into a lower level of security.

**A Security Enabled Z-Wave Controller must be used to fully utilize the Spirit Z-Wave Plus.**

# Inserting batteries

---

Remove the battery cover by simply pulling it off. Now insert the batteries. Pay attention to the correct polarity! At a later battery change, the configuration of your Spirit Z-Wave Plus is maintained.

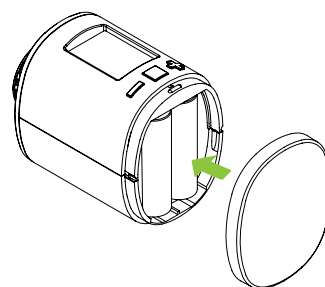
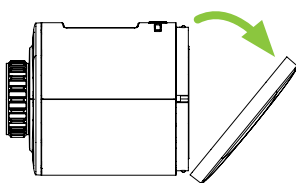



## 4.4 Inclusion

Start Inclusion mode of your primary Z-Wave Controller.

Press the Boost-Button.

Spirit Z-Wave Plus will show the assigned NodeID.

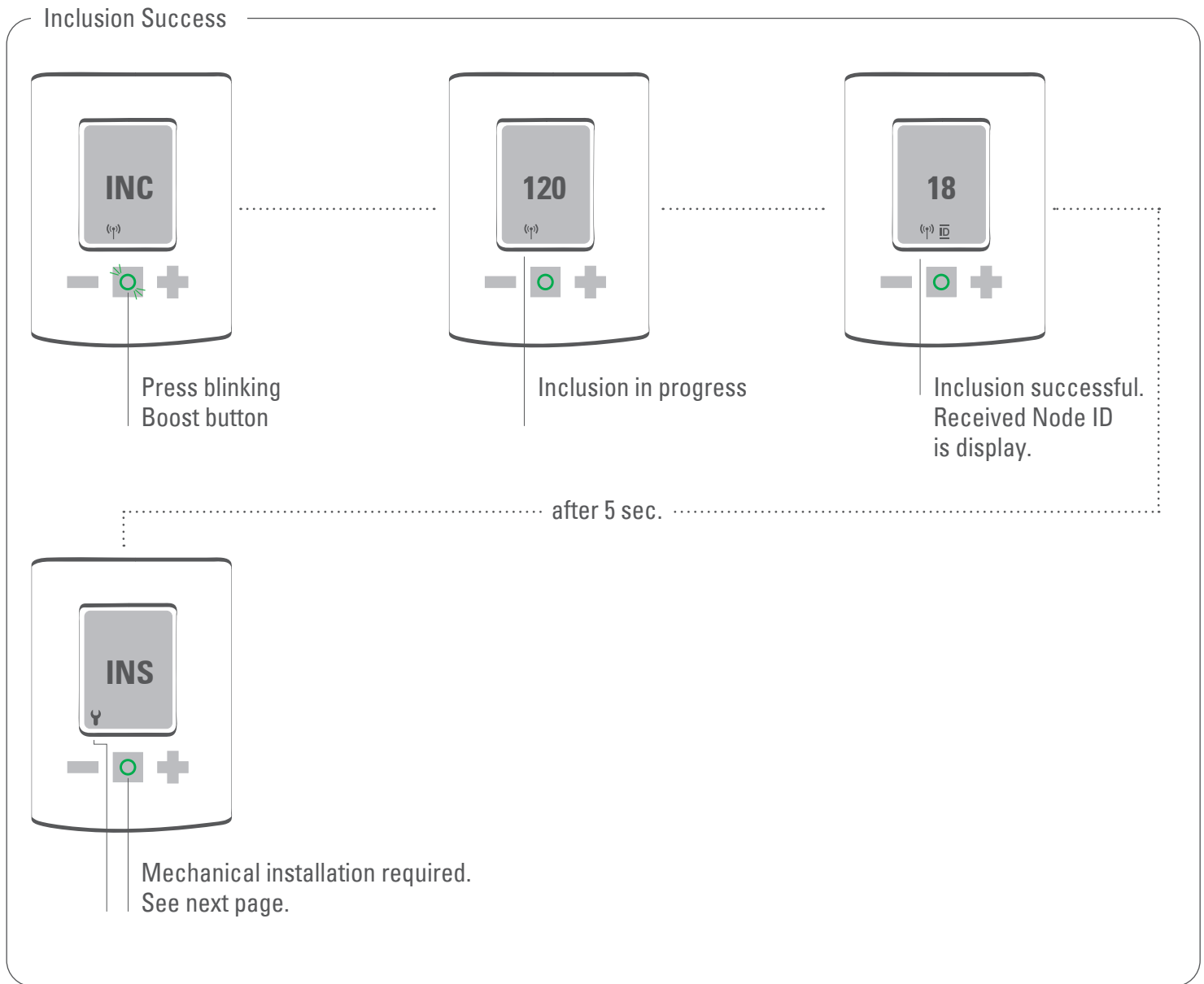

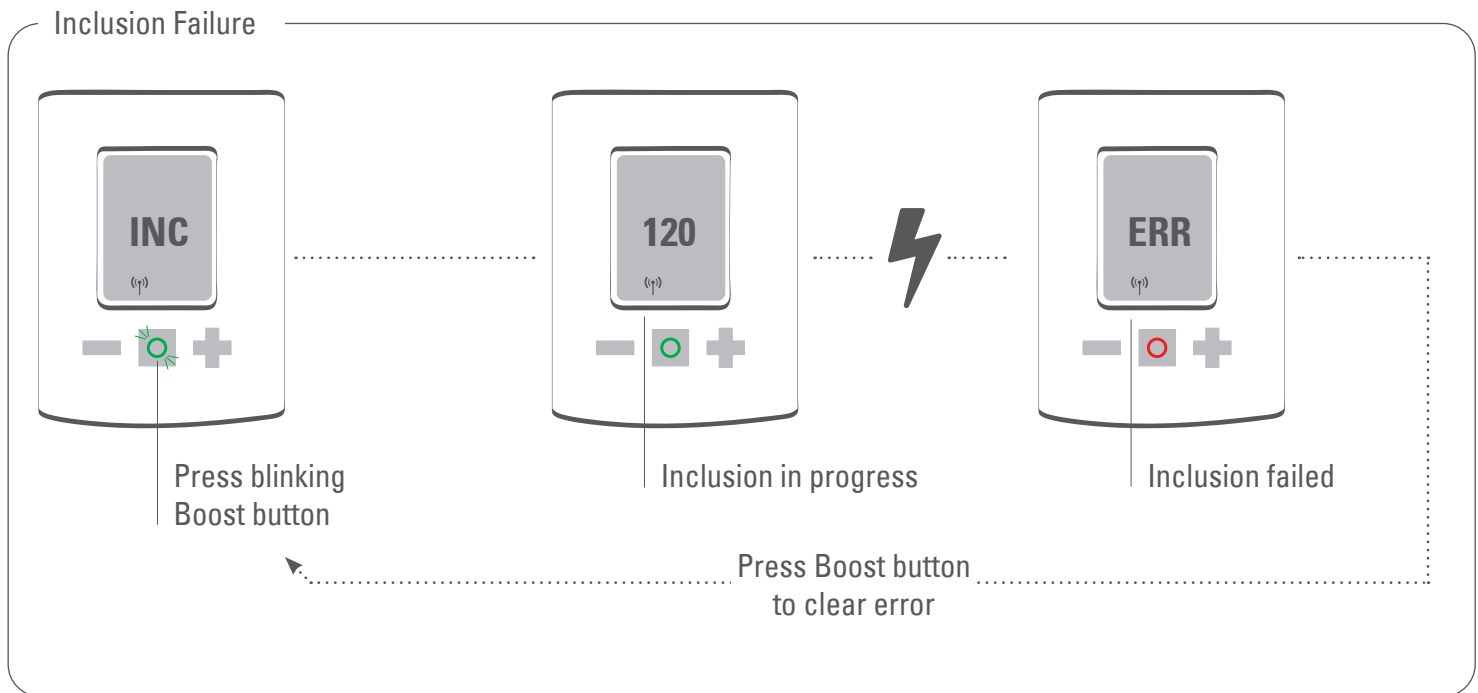

## 4.5 Mounting the Spirit Z-Wave Plus

After adding the Spirit Z-Wave Plus to a network it is ready to be installed on the radiator. The LCD shows INS. Do not press the boost button yet. If successfully installed to the radiator proceed with 4.6.

Installation at the radiator without Adapter

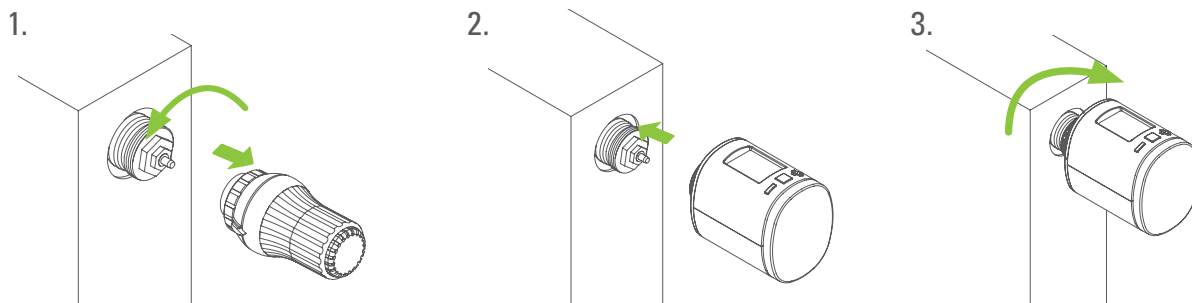

Installation at the radiator with Adapter

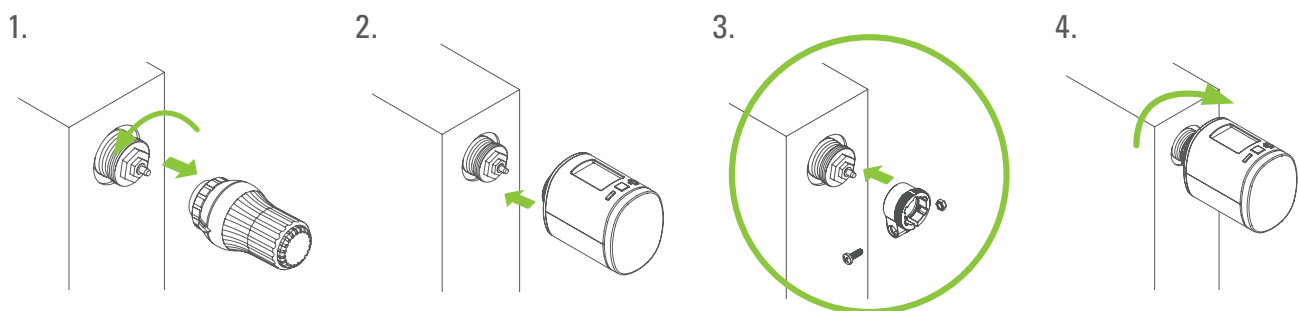

## 4.6 Mechanical Installation

Press the boost button to start mechanical installation.

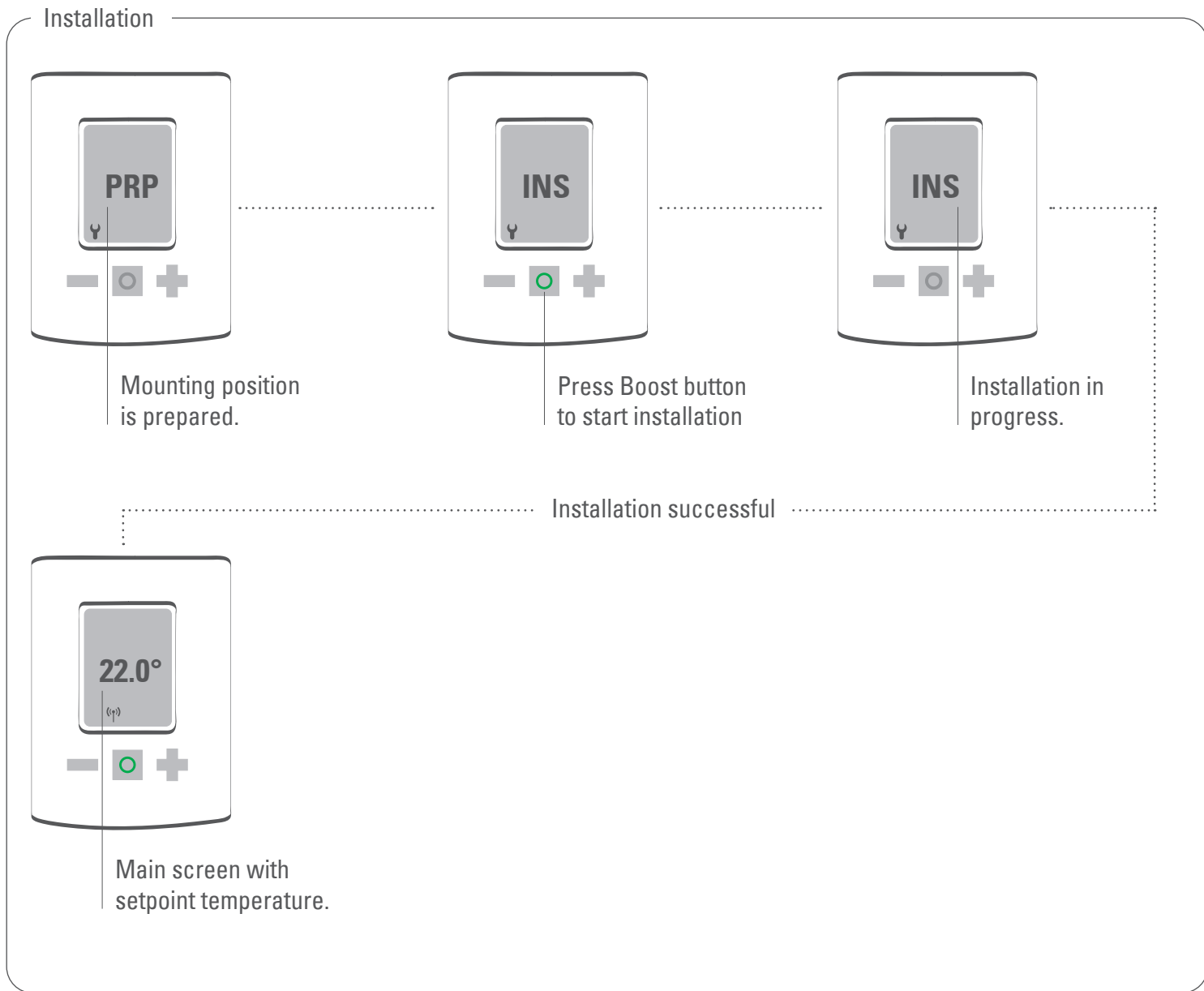

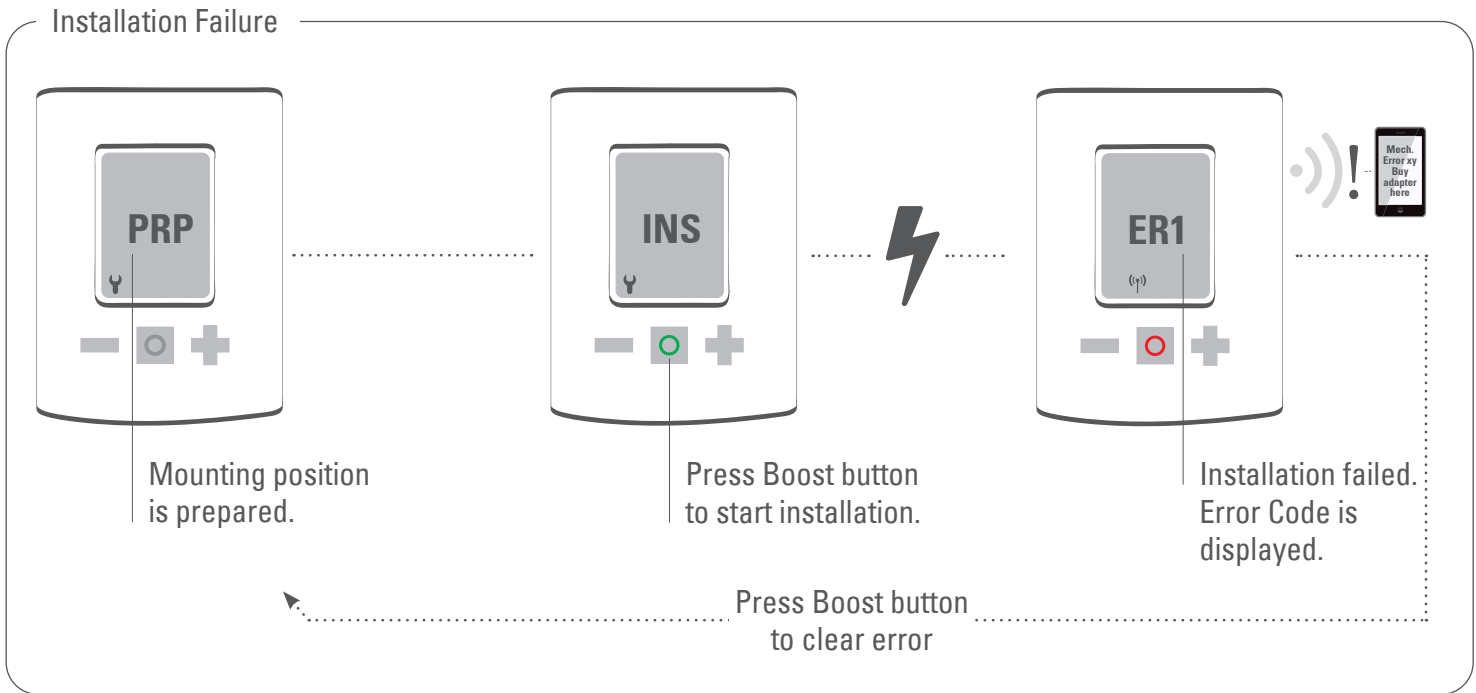

## 4.7 Exclusion

Start Exclusion mode of your primary Z-Wave Controller.

Now press and hold the boost button of the Spirit Z-Wave Plus for at least 5 seconds.

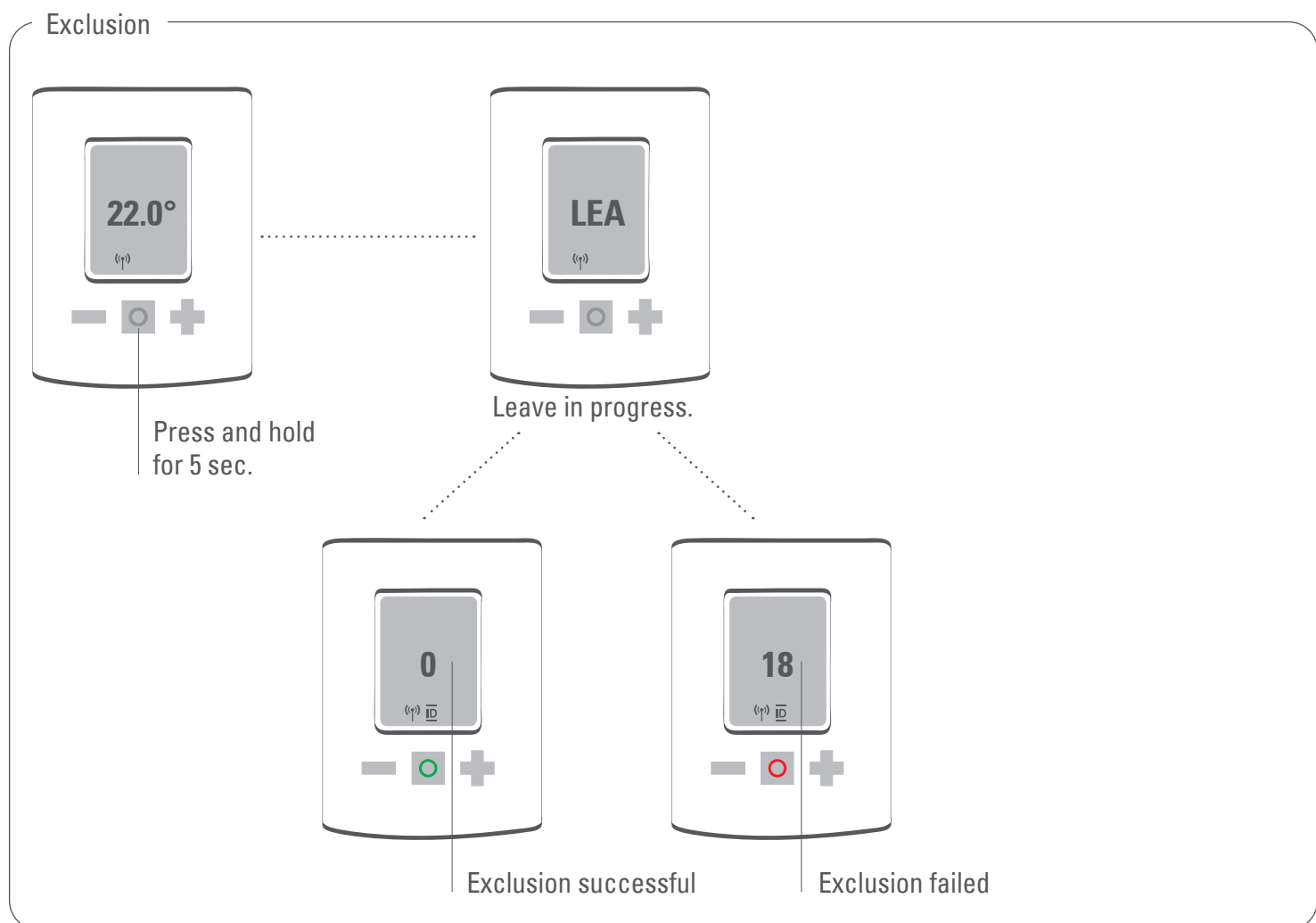

## 4.8 Unmounting the Spirit Z-Wave Plus

Remove the Spirit Z-Wave Plus from the Z-Wave network before unmounting it. Follow the process described in Exclusion and wait until the LCD shows INC. You can now uninstall Spirit Z-Wave Plus from the radiator.

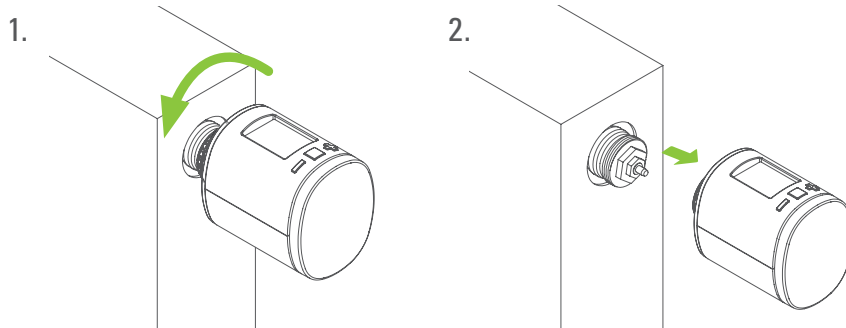

## 4.9 Factory Reset

Remove batteries.  
Press and hold boost button.  
While still holding boost button insert batteries.  
The LCD shows RES. Release boost button.  
To perform the factory reset press boost button.

Please use this procedure only when the network primary controller is missing or otherwise inoperable.

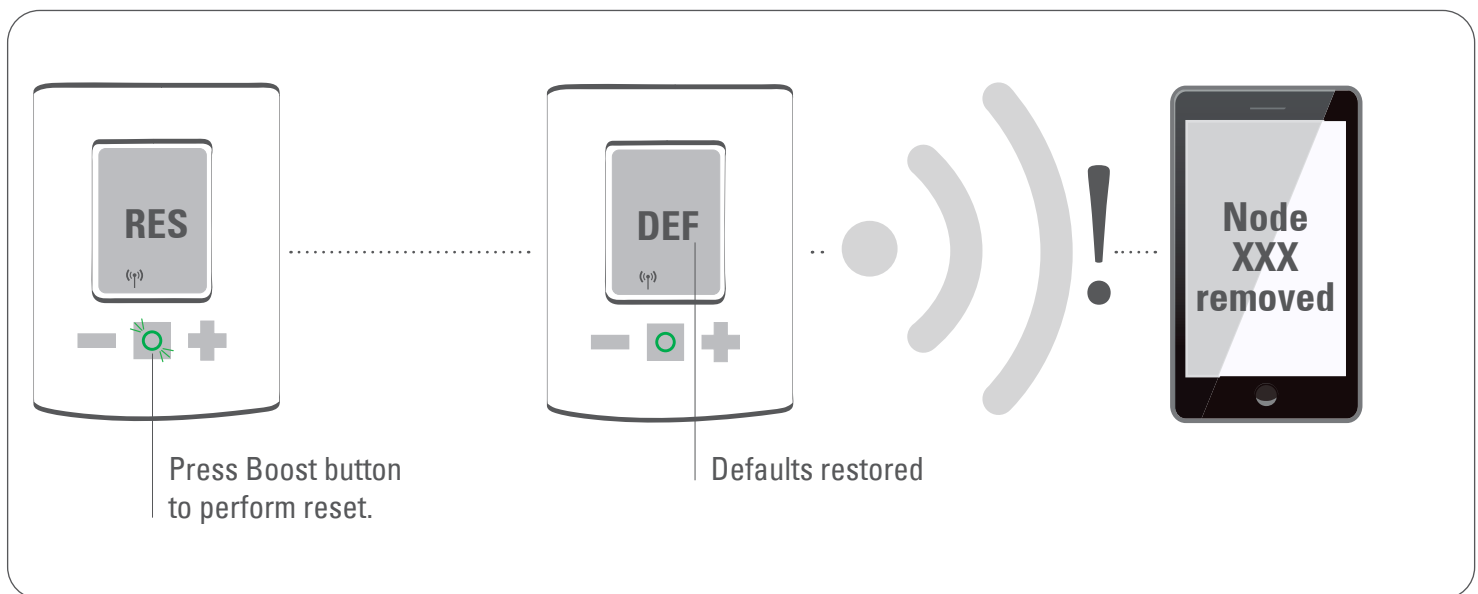

# 5 Operating the device

---

The LCD shows the configured set point or the valve opening percentage if the device is in manufacturer specific mode.

## 5.1 Setpoint adjustment

The setpoint is adjusted via plus and minus button.

Altering the setpoint locally will set the Spirit Z-Wave Plus in heating mode.

The energy saving setpoint can only be adjusted via Z-Wave.

The configurable setpoint range is 8°C to 28°C.

If the setpoint is increased/decreased above/below the set point limits the Spirit Z-Wave Plus will change into boost / off –mode.

## 5.2 Child protection

Press and hold plus and minus button simultaneously for 3 seconds to enable/disable the child protection.

If the Spirit Z-Wave Plus is set into the highest protection level it is no longer possible to operate the device locally.

## 5.3 Altering the operating states

### Off-Mode

Press minus button until OFF is displayed.

### Boost-Mode

Push the boost button.

Alternatively press the plus button until ON is displayed.

### Heating-Mode

If the operating state is not heating mode, pressing the plus or minus button will bring the device in heating mode.

## **5.4 Window open detection**

If the room temperature drops the window open detection will trigger. Spirit Z-Wave Plus will change temporarily in off mode for 15 minutes.

Window open detection will end automatically after 15 minutes and the previously active operating mode will be restored.

Window open detection can also be canceled by a button press.

The window open detection is disabled during manufacturer specific mode.

The sensitivity of the window open detection can be configured

## **5.5 Display NodeID**

Press and hold the boost button for 3 seconds to display the NodeID.

# 6 Z-Wave

Command Class	Description	Version	Control (C) Support (S)	Security *
Association	Allows to associate with other Z-Wave devices.	2	S	U, S0, S2
Association Group Information	Allows to group associations.	1	S	U, S0, S2
Basic	Provides access to basic functionality.	1	S	U, S0, S2
Battery	Returns the current battery level of the device.	1	S	U, S0, S2
Configuration	Allows to configure the device settings.	1	S	U, S0, S2
Device Reset Locally	Informs the Z-Wave Controller that the device was factory reset.	1	S	U, S0, S2
Manufacturer Specific	Provides information about Manufacturer and Product.	1	S	U, S0, S2
Multilevel Sensor	Provides the measured room temperature.	5	S	U, S0, S2
Multilevel Switch	Provides or sets the valve opening degree of the valve Controlling the valve opening degree requires manufacturer specific mode.	1	S	U, S0, S2
Notification	Informs the controller about critical system events/errors.	8	S	U, S0, S2
Power Level	Used to alter the rf-power(required by Z-Wave).	1	S	U, S0, S2
Protection	Allows to lock the device(child protection).	1	S	U, S0, S2
Security	Allows encrypted Z-Wave Communication.	2	S	U
Thermostat Mode	Configures the operation mode.	3	S	U, S0, S2
Thermostat Setpoint	Allows to configure the desired room temperature.	3	S	U, S0, S2
Transport Service	Handles the transmission of large telegrams.	2	S	U
Version	Returns information about the Firmware.	2	S	U, S0, S2
Z-Wave Plus Info	Identifies the device as a Z-Wave Plus Device.	1	S	U

\*Availability of the Command Class after adding the Spirit Z-Wave Plus to your Z-Wave network.

U Unsecure

S0 Z-Wave Security standard S0

S2 Z-Wave Security standard S2



## 6.1 Association

Spirit Z-Wave Plus can only be associated with the Z-Wave controller.

Group No	Description	Commands	Max supported Nodes
1	Lifeline	BATTERY_REPORT, DEVICE_RESET_LOCALLY_NOTIFICATION, THERMOSTAT_MODE_REPORT, THERMOSTAT_SETPOINT_REPORT, NOTIFICATION_REPORT, PROTECTION_REPORT, SENSOR_MULTILEVEL_REPORT, SWITCH_MULTILEVEL_REPORT	1

## 6.2 Basic

Control basic functions of the Spirit Z-Wave Plus via basic command class.

Value	Description	Function
0x00	Energy Save Heating	Switches into energy save heating mode. The room temperature will be lowered to the configured setpoint in order to save. energy.
0x0F	OFF	No Heating. Only Frost-protection.
0xF0	Full Power Heating	Switches into Boost mode(Quick heat).
0xFE	Manufacturer Specific	Switches into direct Valve control mode.
0xFF	Heating	Switches into comfort heating mode. The room temperature will be kept at the configured comfortable level.

## 6.3 Configuration

Spirit Z-Wave Plus can be configured during runtime.

Parameter number	Size in Byte	Name	Description
1	1	LCD Invert	<b>0x00</b> LCD-content normal <b>0x01</b> LCD-content inverted (UK Edition) <b>default:</b> 0x00
2	1	LCD Timeout	<b>0x00</b> No Timeout LCD always on <b>0x05-0x1E</b> LCD will turn off after 5 to 30 seconds. <b>default:</b> 0x00
3	1	Backlight	<b>0x00</b> Backlight disabled <b>0x01</b> Backlight enabled <b>default:</b> 0x01
4	1	Battery report	<b>0x00</b> Battery status is only reported as a system notification (Notification CC) <b>0x01</b> Send battery status unsolicited once a day. <b>default:</b> 0x01
5	1	Measured Temperature report	<b>0x00</b> Unsolicited Temperature reporting disabled. <b>0x01 – 0x32</b> report if temperature changed by delta = 0,1°C ... 5,0 °C <b>default</b> 0x05 (report on delta T = 0,5°C)
6	1	Valve opening percentage report	<b>0x00</b> Unsolicited valve opening percentage reporting disabled. <b>0x01-0x64</b> report if valve opening changed by delta = 1% ... 100% <b>default</b> 0x00
7	1	Window open detection	<b>0x00</b> Disabled <b>0x01</b> Sensitivity low <b>0x02</b> Sensitivity medium <b>0x03</b> Sensitivity high <b>default:</b> 0x02 medium
8	1	Measured Temperature offset	<b>0xCE-0x32</b> Offsets the measured temperature by -5,0°C – (+)5,0°C <b>0x80</b> External temperature sensor will be used for regulation. <b>default:</b> 0x00 0,0°C Offset

## 6.4 Multilevel Sensor

Spirit Z-Wave Plus measured the room temperature and automatically reports sensor readings to associated devices. Per default the reporting threshold is  $\pm 0.5^{\circ}\text{C}$ . This parameter can be altered via configuration command class.

The measured room temperature can be adjusted with an offset. Spirit Z-Wave Plus can receive temperature readings from other Z-Wave devices (wall thermostat for example) The external temperature can be used for temperature regulation. This feature has to be enabled via configuration parameter. The Spirit Z-Wave Plus can handle Multilevel Sensor Reports in the following format:

### Report outgoing:

**Sensor type:** „Air Temperature“

**Scale:** Celsius

**Precision:** 2

### Report incoming:

**Sensor type:** „Air Temperature“

**Scale:** Celsius and Fahrenheit

**Precision:** 0, 1 and 2

## 6.5 Multilevel Switch

Allows to request the valve opening in percent. 0% represents a fully shut valve. 100 % a fully open valve. The valve opening can be reported on change. If the configuration parameter is set.

Controlling the valve directly via multilevel switch command class is only possible if Spirit Z-Wave Plus is in manufacturer specific mode

## 6.6 Notification

Spirit Z-Wave Plus will send notifications on certain events.

Notification type	Reason	Description
Power Management	Replace battery soon	Notification is sent if less than 25% battery remaining
Power Management	Replace battery now	Notification is sent if less than 15% battery remaining
System	System Hardware failure with manufacturer proprietary failure code	Provides manufacturer specific error codes for mechanical problems <b>0x01</b> Motor movement not possible <b>0x02</b> Not mounted on a valve <b>0x03</b> Valve closing point could not be detected <b>0x04</b> Piston positioning failed

## 6.7 Protection

Spirit Z-Wave Plus can be locked remotely.

Protection level	Description
0x00	Unprotected regular operation possible
0x01	Restricted: device can be unlocked using a button pattern.
0x02	No local operation possible.

## 6.8 Thermostat Mode

Spirit Z-Wave Plus offers the following modes.

Mode	Name	Description
0x00	Off	No heating. Only frost protection.
0x01	Heat	Switches into comfort heating mode. The room temperature will be kept at the configured comfortable level.
0x0B	Energy Heat	Switches into energy save heating mode. The room temperature will be lowered to the configured setpoint in order to save energy.
0x0F	Full Power	Switches into Boost mode (Quick heat). Spirit Z-Wave Plus heats the room up as fast as possible. The mode is left automatically after 5 minutes or earlier if requested by the user(via Z-Wave or locally on the device).
0x1F	Manufacturer Specific	Switches into direct valve control mode. The valve opening percentage can be controlled using the Switch multilevel command class.

## 6.9 Thermostat Setpoint

The following setpoints of the Spirit Z-Wave Plus can be altered.

Modus	Name	Precision	Scale	Temp. Range
0x01	Heat	0,1 and 2	Celsius and Fahrenheit	8°C-28°C
0x0B	Energy Heat	0,1 and 2	Celsius and Fahrenheit	8°C-28°C

# 7 Troubleshooting

Problem	Reason	Solution
Batterie Icon	Batteries do not have enough power.	Replace batteries.
Heating element does not warm up.	Is the boiler water temperature O.K.? Valve does not open, is it calcified after the summer pause/heating pause.	Adjust the temperature of the boiler water. Remove the Spirit Z-Wave Plus, move the valve back and forth per hand or with a tool.
Heating element does not cool down.	Valve does not close completely. It may be that the closing point of your valve seat has shifted.	Unmount Spirit Z-Wave Plus. Move the valve stem several times by hand, it may be that adaptation is impossible because your valve is calcified or the seat no longer performs its function.
Pressure piece falls out (This can also cause an E1-error)	Due to an endless thread the pressure piece, which is situated at the bottom, can fall out if the device has not been affixed on the valve.	Remove batteries. Put in the pressure piece. Insert the batteries. The endless thread is rotating now and fixes the pressure piece again.
ER1-3 and ERR	The error code can be cleared by pressing the boost button.	
Err	Inclusion failed	Z-Wave Controller out of range.
ER1	Valve positioning not possible	Check if the valve is jammed.
ER2	Valve not detected	Check if the Spirit Z-Wave Plus is correctly mounted.
ER3	Valves closing point not detected	Check if the Spirit Z-Wave Plus is correctly mounted.